

IV-K2R

Full HD A/D Board Specification

Date : 2022.08.08



IVIEWKOREA

Table of Contents

1. System Specification	3
2. System Block Diagram	4
3. Board Layout Drawing	5
4. Board Picture	5
5. Connector Specification	6~13
6. Support Display Modes	14
7. OSD Menu	15
8. RS-232 Communication Protocol	16

1. System Specification

Item		Description
System	MCU	Multi-Function Display Controller
	Flash	Serial NOR Flash, 16Mbit
Video Input	HDMI	Max Resolution 1920 x 1080@60Hz
	DVI	Max Resolution 1920 x 1080@60Hz
	VGA	Max Resolution 1920 x 1080@60Hz
Video Output	LVDS	Max Resolution 1920 x 1200@60Hz
Input/ Output Port	OSD Key Input 1	OSD 6 Key : POWER, MENU, UP, DOWN, SELECT, AUTO LED : Green LED
	OSD Key Input 2	OSD 6 Key : POWER, MENU, UP, DOWN, SELECT, AUTO LED : Green LED
	Backlight Control 1	Power Supply Out, On/Off, Dimming(PWM)
	Backlight Control 2	Power Supply Out, On/Off, Dimming(PWM)
	Backlight Control 3	Power Supply Out, On/Off, Dimming(PWM)
	Temp. Sensor	ADC Input : Temperature Sensor
	Illumination Sensor	ADC Input : Illumination Sensor
	Proximity Sensor	Proximity Sensor Input
	Digital Sensor	I2C Interface Sensor
	External Power	Power Supply 5V12V out
	Fan	External FAN Power Out
	Audio In	Audio Line Input : Left/Right
	Speaker Out	Speaker Output : Left N/P, Right N/P
	RS-485	External RS-485 Port
	DC IN 1	Power Supply Input
DC IN 2	Power Supply Input	
Temperature Range		Operating: 0 to +70°C Storage: -30 to +80°C
PCB		140 x 90mm, 1.6T, 2LAYER

1-1. Electrical Specification

Description		Min	Typ.	Max	Unit	Remark
Power Supply Voltage		10.8	12	13.2	V	J702
		21.6	24	26.4	V	Selectable
LCD Power	3.3V	3.0	3.3	3.6	V	J501 Selectable
	5V	4.5	5.0	5.5	V	
	12V	10.8	12	13.2	V	
Power Consumption				2	W	Only board

2. System Block Diagram

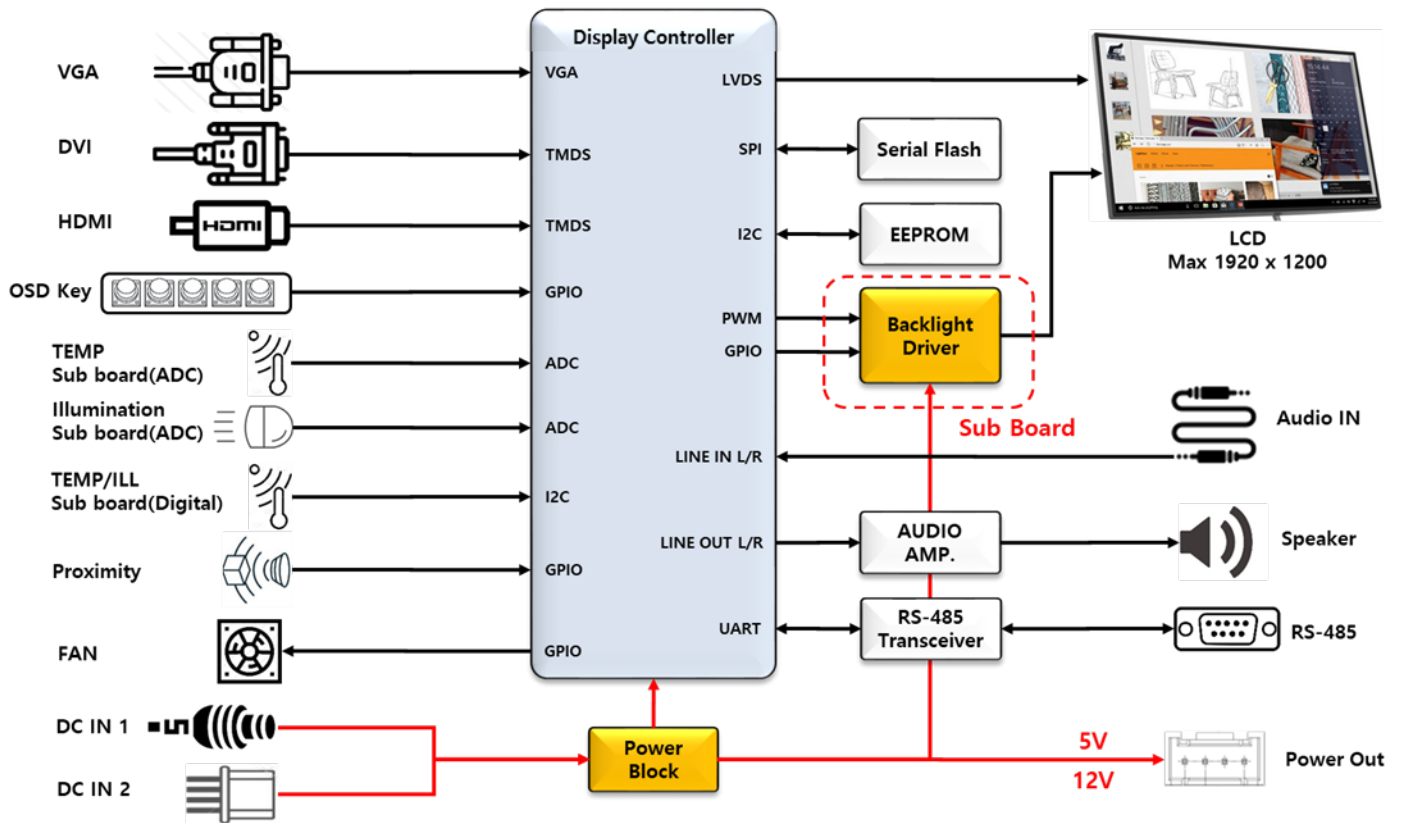

3. Board Layout Drawing

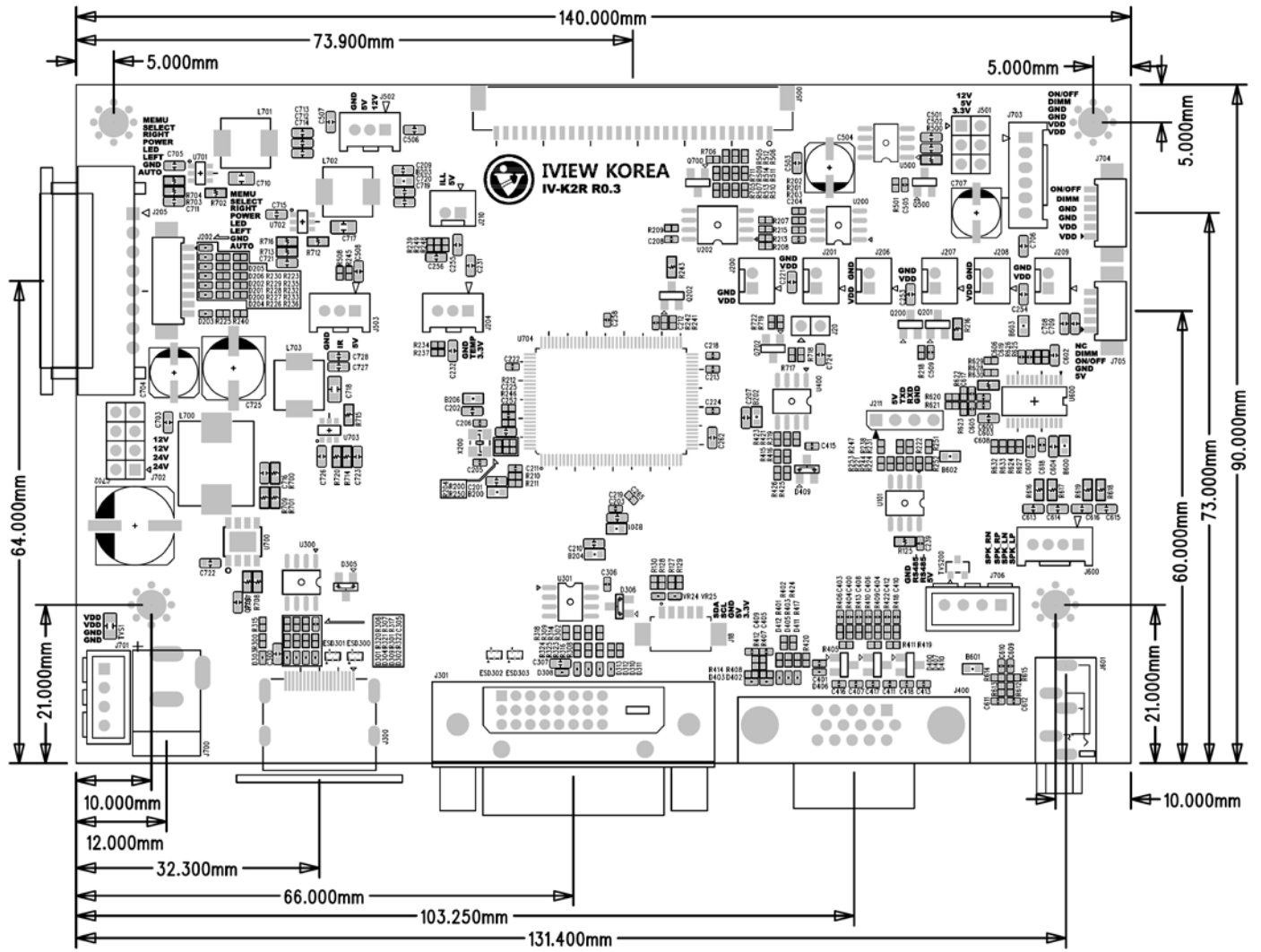

4. Board Picture

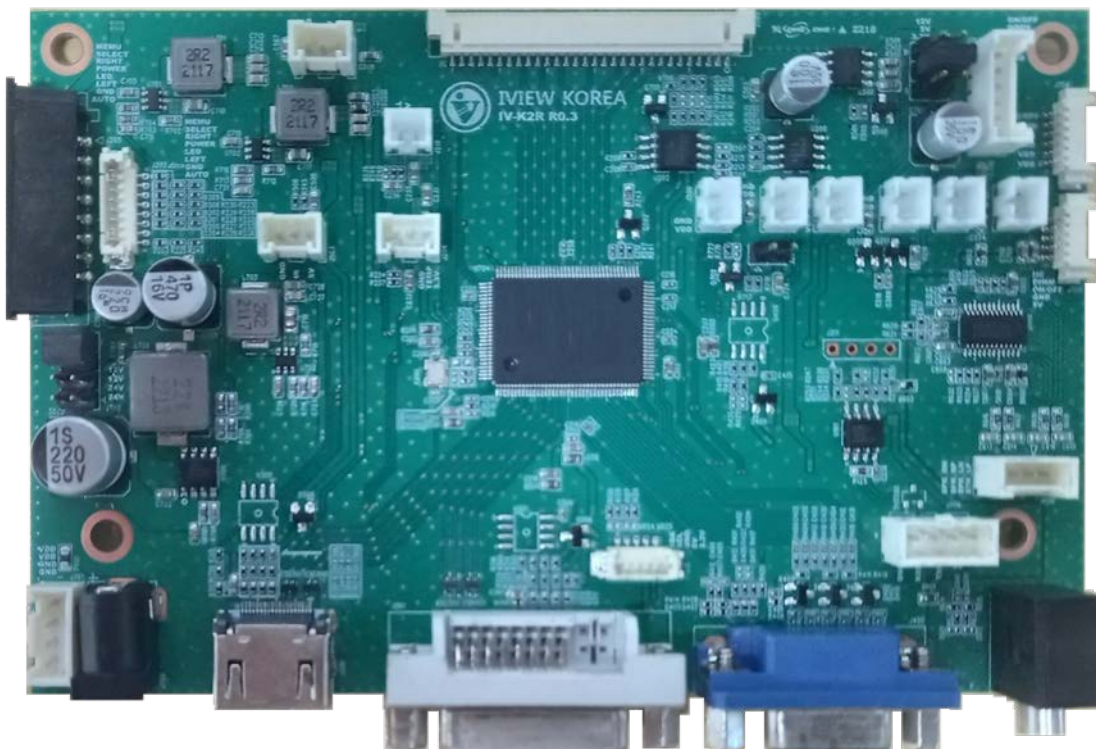

5. Connector Specification

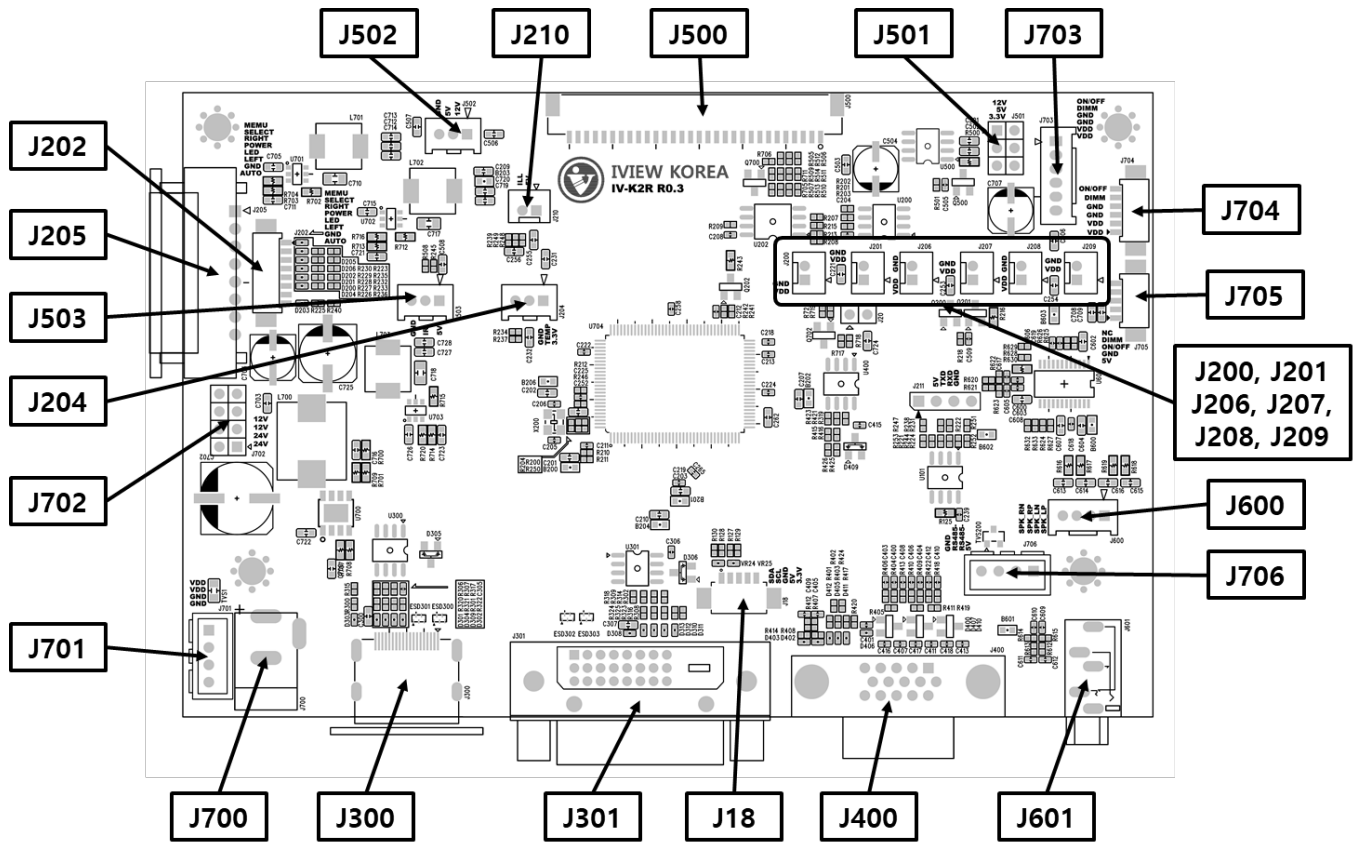

No.	Reference	Part Name	Description	Function	Housing
5-1	J18	12505WS-05A00	Straight, 5pin, 1.25mm	Digital Sensor	12505HS-05
5-2	J200, J201 J206, J207, J208, J209	20010WS-02	Straight, 2pin, 2.00mm	Fan Power Out	20010HS-02
5-3	J202	12505WS-08A00	Straight, 8pin, 1.25mm	OSD Key Input 1	12505HS-08
5-4	J204	SMW200-03P	Straight, 3pin, 2.00mm	Temp. Sensor	SMH200-03
5-5	J205	FCZ254-08R	Right angle, 8pin, 2.54mm, FPCB	OSD Key Input 2	
5-6	J210	20010WS-02	Straight, 2pin, 2.00mm	Illumination Sensor	20010HS-02
5-7	J300	51U019S-30S1N-AR BIM	Right angle, HDMI Receptacle	HDMI Input	HDMI Cable
5-8	J301	DVI 25SR-R	Right angle, DVI connector	DVI Input	DVI Cable
5-9	J400	HDR15F3.08	Right angle, 15pin D-Sub Connector	VGA Input	D-Sub Cable
5-10	J500	12507WR-30A00	Straight, 30pin, 2.00mm	LVDS Output	12507HS-30
5-11	J501	PH01-06DS	Straight, 2x3pin, 2.54mm	LCD Power Select	
5-12	J502	SMW200-03P	Straight, 3pin, 2.00mm	External Power Out	SMH200-03
5-13	J503	SMW200-03P	Straight, 3pin, 2.00mm	Proximity Input	SMH200-03
5-14	J600	SMW200-04P	Straight, 4pin, 2.00mm	Speaker	SMH200-04
5-15	J601	PJ-325	Right angle, 3.5mm, Phone jack	Audio Input	
5-16	J700	DC-005Y/2.5	Right angle, DC Jack(Φ 2.5)	Power Supply Input 1	
5-17	J701	SMW250-04P	Straight, 4pin, 2.50mm	Power Supply Input 2	SMH250-04
5-18	J702	PH01-08DS	Straight, 2x4pin, 2.54mm	Power Supply Select	
5-19	J703	SMW200-06P	Straight, 6Pin, 2.00mm	Backlight Interface 1	SMH200-06
5-20	J704	12505WR-06A00	Right angle, 6pin, 1.25mm	Backlight Interface 2	12505HS-06
5-21	J705	12505WR-05A00	Right angle, 5pin, 1.25mm	Backlight Interface 3	12505HS-05
5-22	J706	SMW250-04P	Straight, 4pin, 2.50mm	RS-485	SMH250-04

5-1. J18(Digital Sensor)

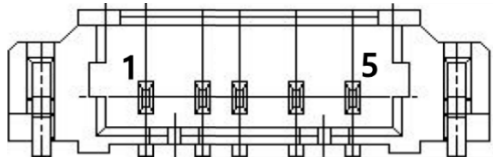
Pin no.	Signal	Description	Connector pin arrangement
1	SENSOR_SDA	Serial Data Signal	
2	SENSOR_SCL	Serial Clock Signal	
3	GND	GND	
4	5V	5V Power Out	
5	3.3V	3.3V Power Out	

5-2. J200, J201, J206, J207, J208, J209(Fan Power Out)

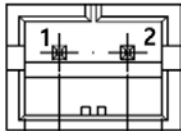
Pin no.	Signal	Description	Connector pin arrangement
1	VDD	12V Power Out	
2	GND	GND	

5-3. J202(OSD Key Input 1)

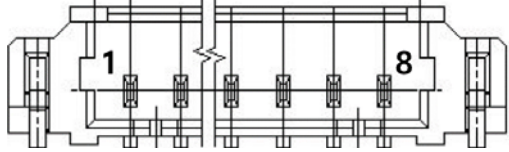
Pin no.	Signal	Description	Connector pin arrangement
1	CON_MENU	Menu Key Input	
2	CON_SEL	Select Key Input	
3	CON_RIGHT	Right(Up) Key Input	
4	CON_POWER	Power Key Input	
5	EXT_LED	LED Green	
6	CON_LEFT	Left(Down) Key Input	
7	GND	GND	
8	CON_AUTO	Auto Key Input	

5-4. J204(Temp. Sensor)

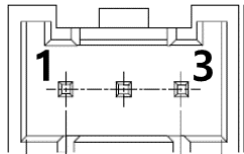
Pin no.	Signal	Description	Connector pin arrangement
1	3.3V	3.3V Power Out	
2	TEMP_ADC	Temperature Sensor ADC Input	
3	GND	GND	

5-5. J205(OSD Key Input 2)

Pin no.	Signal	Description	Connector pin arrangement
1	CON_MENU	Menu Key Input	
2	CON_SEL	Select Key Input	
3	CON_RIGHT	Right(Up) Key Input	
4	CON_POWER	Power Key Input	
5	EXT_LED	LED Green	
6	CON_LEFT	Left(Down) Key Input	
7	GND	GND	
8	CON_AUTO	Auto Key Input	

5-6. J210(Illumination Sensor)

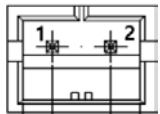
Pin no.	Signal	Description	Connector pin arrangement
1	5V	5V Power Out	
2	ILL_ADC	Illumination Sensor ADC Input	

5-7. J300(HDMI Receptacle)

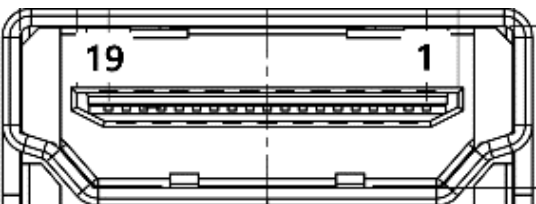
Pin no.	Signal	Description	Connector pin arrangement
1	HDMI_RX2P	TMDS Data 2 Positive Input	
2	GND	GND	
3	HDMI_RX2N	TMDS Data 2 Negative Input	
4	HDMI_RX1P	TMDS Data 1 Positive Input	
5	GND	GND	
6	HDMI_RX1N	TMDS Data 21Negative Input	
7	HDMI_RX0P	TMDS Data 0 Positive Input	
8	GND	GND	
9	HDMI_RX0N	TMDS Data 0 Negative Input	
10	HDMI_RXCP	TMDS Clock Positive Input	
11	HDMI_CABLE_DET	GND	
12	HDMI_RXCN	TMDS Clock Negative Input	
13	NC	No Connection	
14	NC	No Connection	
15	HDMI_SCL	DDC Serial Clock Input	
16	HDMI_SDA	DDC Serial Data Input	
17	GND	GND	
18	HDMI_5V	5V Power Input	
19	HDMI_HPD	HDMI Hot Plug Detect Signal	

5-8. J301(DVI connector)

Pin no.	Signal	Description	Connector pin arrangement
1	DVI_RX2N	TMDS Data 2 Negative Input	
2	DVI_RX2P	TMDS Data 2 Positive Input	
3	GND	GND	
4	NC	No Connection	
5	NC	No Connection	
6	DVI_SCL	DDC Serial Clock Input	
7	DVI_SDA	DDC Serial Data Input	
8	NC	No Connection	
9	DVI_RX1N	TMDS Data 1 Negative Input	
10	DVI_RX1P	TMDS Data 1 Positive Input	
11	GND	GND	
12	NC	No Connection	
13	NC	No Connection	
14	DVI_5V	5V Power Input	
15	DVI_CABLE_DET	DVI Cable Detect Signal	
16	DVI_HPD	DVI Hot Plug Detect Signal	
17	DVI_RX0N	TMDS Data 0 Negative Input	
18	DVI_RX0P	TMDS Data 0 Positive Input	
19	GND	GND	
20	NC	No Connection	
21	NC	No Connection	
22	GND	GND	
23	DVI_RXCN	TMDS Clock Negative Input	
24	DVI_RXCP	TMDS Clock Positive Input	

5-9. J400(VGA Input)

Pin no.	Signal	Description	Connector pin arrangement
1	RED	VGA RED Input	
2	GREEN	VGA Green Input	
3	BLUE	VGA Blue Input	
4	NC	No Connection	
5	VGA_CABLE_DET	VGA Cable Detect Signal	
6	RED_M	GND	
7	GREEN_M	GND	
8	BLUE_M	GND	
9	VGA_5V	5V Power Input	
10	GND	GND	
11	NC	No Connection	
12	VGA_TX_SDA	DDC Serial Data Input	
13	HS	VGA Horizontal Sync Input	
14	VS	VGA Vertical Sync Input	
15	VGA_RX_SCL	DDC Serial Clock Input	

5-10. J500(LVDS Output)

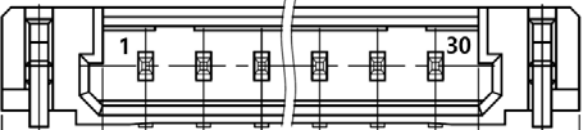
Pin no.	Signal	Description	Connector pin arrangement
1	LCD_VDD	Panel Power Out	
2	LCD_VDD	Panel Power Out	
3	LCD_VDD	Panel Power Out	
4	CON_UD	GPIO Signal	
5	CON_LR	GPIO Signal	
6	CON_INV_ON	GPIO Signal	
7	GND	GND	
8	TXE_3P	LVDS Even Data 3 Positive Output	
9	TXE_3M	LVDS Even Data 3 Negative Output	
10	TXE_CP	LVDS Even Clock Positive Output	
11	TXE_CM	LVDS Even Clock Negative Output	
12	TXE_2P	LVDS Even Data 2 Positive Output	
13	TXE_2M	LVDS Even Data 2 Negative Output	
14	GND	GND	
15	TXE_1P	LVDS Even Data 0 Positive Output	
16	TXE_1M	LVDS Even Data 0 Negative Output	
17	GND	GND	
18	TXE_0P	LVDS Even Data 0 Positive Output	
19	TXE_0M	LVDS Even Data 0 Negative Output	
20	TXO_3P	LVDS Odd Data 3 Positive Output	
21	TXO_3M	LVDS Odd Data 3 Negative Output	
22	TXO_CP	LVDS Odd Clock Positive Output	
23	TXO_CM	LVDS Odd Clock Negative Output	
24	GND	GND	
25	TXO_2P	LVDS Odd Data 2 Positive Output	
26	TXO_2M	LVDS Odd Data 2 Negative Output	
27	TXO_1P	LVDS Odd Data 0 Positive Output	
28	TXO_1M	LVDS Odd Data 0 Negative Output	
29	TXO_0P	LVDS Odd Data 0 Positive Output	
30	TXO_0M	LVDS Odd Data 0 Negative Output	

5-11. J501(LCD Power Select)

Pin no.	Signal	Description	Connector pin arrangement
1	12V	12V Power Out / Jumper 1-2 Connection	
2	LVDS_PWR	LCD Power Supply	
3	5V	5V Power Out / Jumper 3-4 Connection	
4	LVDS_PWR	LCD Power Supply	
5	3.3V	3.3V Power Out / Jumper 5-6 Connection	
6	LVDS_PWR	LCD Power Supply	

5-12. J502(External Power Out)

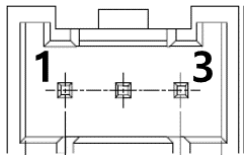
Pin no.	Signal	Description	Connector pin arrangement
1	12V	12V Power Out	
2	5V	5V Power Out	
3	GND	GND	

5-13. J503(Proximity Input)

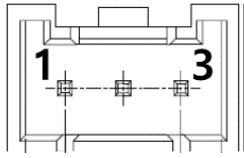
Pin no.	Signal	Description	Connector pin arrangement
1	5V	5V Power Out	
2	IR	Proximity Sensor Input	
3	GND	GND	

5-14. J600(Speaker)

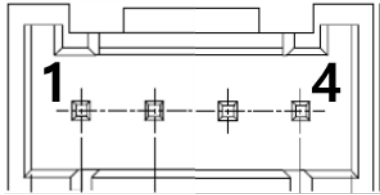
Pin no.	Signal	Description	Connector pin arrangement
1	SPK_OUT_RN	Speaker Right Negative Output	
2	SPK_OUT_RP	Speaker Right Positive Output	
3	SPK_OUT_LN	Speaker Left Negative Output	
4	SPK_OUT_LP	Speaker Left Positive Output	

5-15. J600(Audio Input)

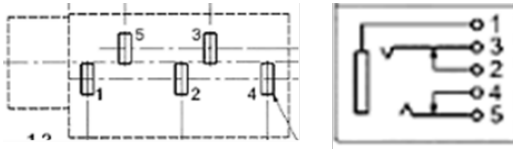
Pin no.	Signal	Description	Connector pin arrangement
1	GND	GND	
2	GND	GND	
3	AUD_LINEIN_R	Audio Right Line Input	
4	GND	GND	
5	AUD_LINEIN_L	Audio Left Line Input	

5-16. J700(Power Supply Input 1)

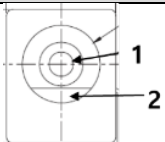
Pin no.	Signal	Description	Connector pin arrangement
1	DC_IN	Power Supply Input	
2	GND	GND	

5-17. J701(Power Supply Input 2)

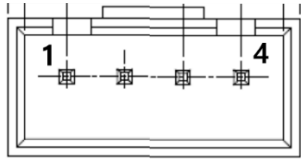
Pin no.	Signal	Description	Connector pin arrangement
1	GND	GND	
2	GND	GND	
3	DC_IN	Power Supply Input	
4	DC_IN	Power Supply Input	

5-18. J702(Power Supply Select)

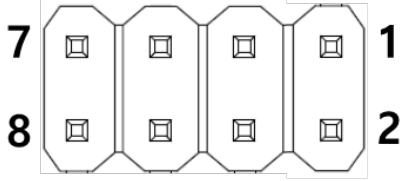
Pin no.	Signal	Description	Connector pin arrangement
1	24V	24V Power Supply Input / Jumper 1-2 Connection	
2	DC_IN	Power Supply Input	
3	24V	24V Power Supply Input / Jumper 3-4 Connection	
4	DC_IN	Power Supply Input	
5	12V	12V Power Supply Input / Jumper 5-6 Connection	
6	DC_IN	Power Supply Input	
7	12V	12V Power Supply Input / Jumper 7-8 Connection	
8	DC_IN	Power Supply Input	

5-19. J703(Backlight Interface 1)

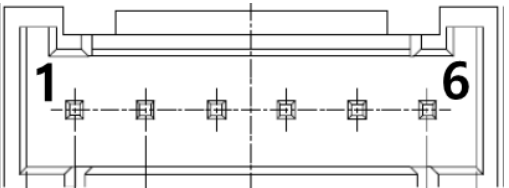
Pin no.	Signal	Description	Connector pin arrangement
1	ON_BLT	Backlight On/Off Control Signal	
2	ADJ_BLT	Backlight PWM Control Signal	
3	GND	GND	
4	GND	GND	
5	VDD	12V Backlight Power Out	
6	VDD	12V Backlight Power Out	

5-20. J704(Backlight Interface 2)

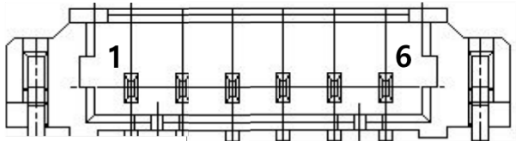
Pin no.	Signal	Description	Connector pin arrangement
1	VDD	12V Backlight Power Out	
2	VDD	12V Backlight Power Out	
3	GND	GND	
4	GND	GND	
5	ADJ_BLT	Backlight PWM Control Signal	
6	ON_BLT	Backlight On/Off Control Signal	

5-21. J705(Backlight Interface 3)

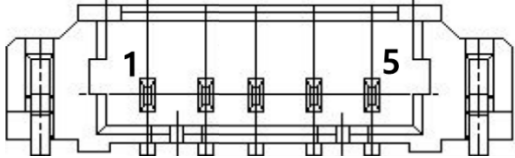
Pin no.	Signal	Description	Connector pin arrangement
1	VDD	5V Backlight Power Out	
2	GND	GND	
3	ON_BLT	Backlight On/Off Control Signal	
4	ADJ_BLT	Backlight PWM Control Signal	
5	NC	No Connection	

5-22. J706(RS-485)

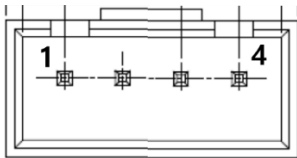
Pin no.	Signal	Description	Connector pin arrangement
1	GND	GND	
2	RS485+	RS-485 Non-inverting driver output / receiver input	
3	RS485-	RS-485 Inverting driver output / receiver input	
4	5V	5V Power Out	

6. Support Display Modes

Mode \ Spec.	Pixel Freq.		Horizontal Timing				Vertical Timing			
			Sync Polar	Freq.	Total	Active	Sync Polar	Freq.	Total	Active
	MHz			KHz	Pixel	Pixel		Hz	Line	Line
640x480 @60Hz	25.175	MAC	N	31.469	800	640	N	59.940	525	480
640x480 @60Hz	25.175	VESA	N	31.469	800	640	N	59.940	525	480
720x400 @70Hz	28.287	VESA	N	31.430	900	720	P	70.000	449	400
640x480 @67Hz	30.240	MAC	N	35.000	864	640	N	66.667	525	480
640x480 @72Hz	31.500	VESA	N	37.861	832	640	N	72.809	520	480
640x480 @75Hz	31.500	VESA	N	37.500	840	640	N	75.000	500	480
800x600 @56Hz	36.000	VESA	P	35.156	1024	800	P	56.250	625	600
800x600 @60Hz	40.000	VESA	P	37.879	1056	800	P	60.317	628	600
800x600 @75Hz	49.500	VESA	P	46.875	1056	800	P	75.000	625	600
800x600 @72Hz	50.000	VESA	P	48.077	1040	800	P	72.188	666	600
832x624 @75Hz	57.284	MAC	N	49.726	1152	832	N	74.551	667	624
1024x768 @60Hz	64.000	MAC	N	48.780	1312	1024	N	60.001	813	768
1024x768 @60Hz	65.000	VESA	N	48.363	1344	1024	N	60.005	806	768
1024x768 @70Hz	75.000	VESA	N	56.476	1328	1024	N	70.070	806	768
1024x768 @75Hz	78.750	VESA	P	60.023	1312	1024	P	75.030	800	768
1280x768 @60Hz	79.500	VESA	P	47.780	1664	1280	P	59.870	798	768
1024x768 @75Hz	80.000	MAC	N	60.241	1328	1024	N	74.927	804	768
1360x768 @60Hz	85.000	VESA	P	47.712	1792	1360	P	60.015	795	768
1280x1024 @60Hz	108.000	VESA	P	63.981	1688	1280	P	60.020	1066	1024
1280x1024 @75Hz	135.000	VESA	P	79.976	1688	1280	P	75.025	1066	1024
1680x1050 @60Hz	147.000	VESA	N	65.160	2256	1680	P	59.944	1087	1050
1600x1200 @60Hz	160.875	VESA	N	74.479	2160	1600	P	59.967	1242	1200
1920x1080 @60Hz	172.750	VESA	N	67.061	2576	1920	P	59.983	1118	1080
1920x1200 @60Hz	193.125	VESA	N	74.508	1292	1920	P	59.990	1242	1200

7. OSD Menu

Main Menu	Sub Menu	Description	Default	Remark
Picture	Backlight	0 ~ 100	100	Hot Key : Down
	Brightness	0 ~ 100	50	
	Contrast	0 ~ 100	50	
	Sharpness	0 ~ 4	2	
Display	Auto Adjustment			VGA Only
	Auto Color			VGA Only
	H Position	0 ~ 100	50	
	V Position	0 ~ 100	50	
	Pixel Clock	0 ~ 100	50	VGA Only
	Phase	0 ~ 100	3	VGA Only
	Aspect Ratio	Full, 16:9, 4:3, 5:4, Original	Full	
Color	Gamma	Off, 1.8, 2.0, 2.2, 2.4	Off	
	Color Temp	Off, 9300K, 7500K, 6500K, 5800K, sRGB, User(R:255, G:255, B:255)	Off	
	Color Effect	Standard, Game, Movie, Photo, Vivid, User	Standard	
	Color Format	RGB, YUV	RGB	
	Hue	0 ~ 100	50	
	Saturation	0 ~ 100	50	
SYSTEM	Temperature	Off, 0 ~ 100	Off	0도~100도
	Light Sensor	Off, 0 ~ 63	Off	값이 낮을수록 약한 밝기에서 동작
	Minimum	0 ~ 100	20	Light Sensor 동작 시 백라이트 밝기 레벨
	Proximity	Off, 60 ~ 300	Off	센서 동작 후 대기 시간 60초~300초, 5초단위로 조절
Input	-	Auto Select, VGA, HDMI, DVI	Auto Select	
Audio	Volume	0 ~ 100	50	Hot Key : Up
	Mute	On, Off	Off	
	Stand alone	On, Off	Off	사용 안 함
	Audio source	Analog, Digital	-	Analog : VGA, DVI Digital : HDMI
Other	Reset	Factory reset		
	Menu Time	0 ~ 60	10	
	OSD H Position	0 ~ 100	50	
	OSD V Position	0 ~ 100	50	
	Transparency	0 ~ 7	2	
	Rotate	On, Off	Off	On : OSD 메뉴 시계 방향으로 270도 회전

8. RS-485 Communication Protocol

- Both: Request / Response 총 길이(5Byte)

Header(1)	Command(1)		Data Type(1)	Data(1)	Check(1)		
Request: 0xCA	Power	0x01	0x00: Value 0xFF: Status Read	0x00: Power Off 0x01: Power On	-		
	Input Select	0x02	0x00: Value 0xFF: Status Read	0x00: VGA 0x01: DVI 0x02: HDMI	-		
	Auto Adjust	0x03	0x00: Value	0x01: 실행	-		
	Brightness	0x04	0x00: Value 0x80: Decrease by 1 0x81: Increase by 1 0xFF: Status Read	0x00(0) ~ 0x64(100)	-		
	Contrast	0x05	0x00: Value 0x80: Decrease by 1 0x81: Increase by 1 0xFF: Status Read	0x00(0) ~ 0x64(100)	-		
	Backlight	0x06	0x00: Value 0x80: Decrease by 1 0x81: Increase by 1 0xFF: Status Read	0x00(0) ~ 0x64(100)	0x90: Jog Dec by 10 0x91: Jog Inc by 10		
	Reset All Settings	0x07	0x00: Value	0x01: 실행	-		
	Response: 0x35	Volume	0x08	0x00: Value 0x80: Decrease by 1 0x81: Increase by 1 0xFF: Status Read	0x00(0) ~ 0x64(100)	-	
		Temperature	0x11	0x00: Value 0x80: Decrease by 1 0x81: Increase by 1 0xFF: Status Read	0x00(0) ~ 0x64(100)	-	
		Light Sensor	0x12	0x00: Value 0x80: Decrease by 1 0x81: Increase by 1 0xFF: Status Read	0x00(OFF) ~ 0x3F(63)	-	
Light Minimum		0x13	0x00: Value 0x80: Decrease by 1 0x81: Increase by 1 0xFF: Status Read	0x00(0) ~ 0x64(100)	-		
Proximity		0x14	0x00: Value 0x80: Decrease by 1 0x81: Increase by 1 0xFF: Status Read	0x00(OFF) ~ 0x31(49) Time = (Data-1)*5+60 Time : 60sec ~ 300sec	-		
Response: 0x35	Protocol Error (비정상적인 명령어)	0xFF	0x01	0x00	-	존재하지 않는 Protocol, Checksum 값이 맞지 않을 때	
	Not active (동작 할 수 없는 상태)	0xFF	0x02	0x00	-	Backlight 값과 Light Minimum 값 충돌 시	

- Check Byte = Header(1) XOR Command(1) XOR Data Type(1) XOR Data(1)

- 명령어 예

* Power Status read: 0xCA 0x01 0xFF 0x00 0x34

* Power On: 0xCA 0x01 0x00 0x00 0xCB

* Power Off: 0xCA 0x01 0x00 0x01 0xCA